



Film Capacitors – Power Electronic Capacitors

General purpose applications

Series/Type: FilterCap MKD AC – Three phase
Ordering code: B3237*E/F*
Date: 2023-08-21
Version: 1

Rated capacitance: 3 x 5 ... 3 x 400 μ F

Rated Voltage: 350 ... 1415 V AC

RMS Voltage: 250 ... 1000 V

Construction

- Metallized polypropylene film
- Aluminum can and top
- Filling material: Soft polyurethane resin (Non PCB)
- Diameter: 50/63.5/75/85/96/116/136 mm

Features

- Self-healing properties
- Low dissipation factor
- Overpressure disconnecter
- Naturally air cooled (or forced air cooling)
- Protection Degree (indoor mounting)
 - IP00: B32375 and B32376 series
 - IP20: B32377 and B32378 series
- RoHS compatible
- UL Certified

Application

- Input and output filters in inverter systems
- Filtering of harmonic distortion in power inverters

Terminals

- B32375 series: Fast-on terminals
- B32376 series: (M10) screw terminals
- B32377 series: (M5) clamp terminals Type A, Type B
- B32377 series: (M6) clamp terminals Type C
- B32378 series: (M5) clamp terminals Type D, Type E

Mounting

- Threaded stud on the bottom (M12)
- Optional (M16) for critical applications

Packing

- 50 mm diameter: 50 capacitors/box
- 63.5 mm diameter: 12 capacitors/box
- 75 mm diameter: 6 capacitors/box
- 85/96/116/136 mm diameter: 4 capacitors/box



B32375E/F



B32376E/F









B32377E/F

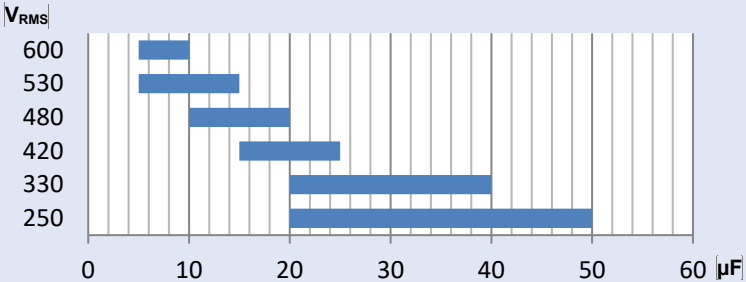

B32378E/F

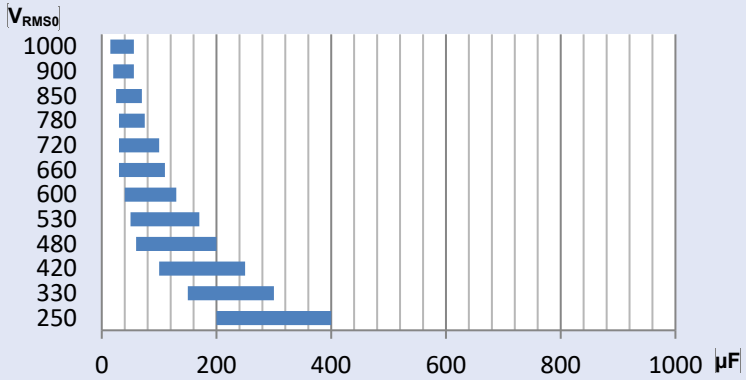
Specifications and characteristics

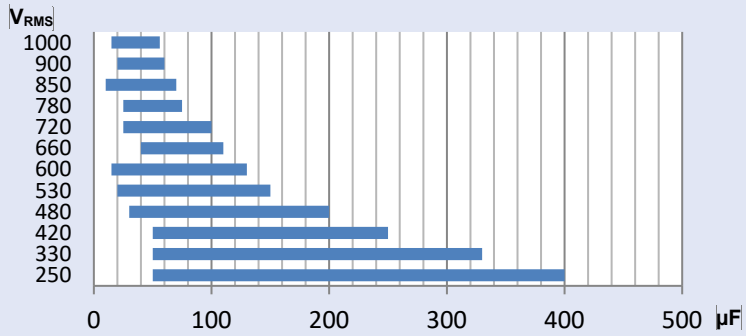
Rated capacitance C_R : 3 x 5 ... 3 x 400 μF , Tolerance: $\pm 5\%$

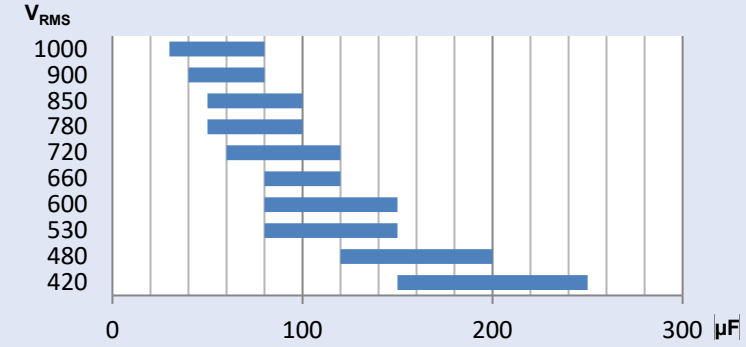
Technical data																							
Type/series	Voltage vs Capacitance																						
<p>B32375E/F* Fast-on terminals Delta connection, Coming soon</p> 	 <table border="1"> <caption>Approximate data for B32375E/F*</caption> <thead> <tr> <th>Capacitance (μF)</th> <th>V_{RMS} (V)</th> </tr> </thead> <tbody> <tr><td>5</td><td>600</td></tr> <tr><td>10</td><td>530</td></tr> <tr><td>15</td><td>480</td></tr> <tr><td>20</td><td>420</td></tr> <tr><td>30</td><td>330</td></tr> <tr><td>40</td><td>250</td></tr> </tbody> </table>	Capacitance (μF)	V _{RMS} (V)	5	600	10	530	15	480	20	420	30	330	40	250								
Capacitance (μF)	V _{RMS} (V)																						
5	600																						
10	530																						
15	480																						
20	420																						
30	330																						
40	250																						
<p>B32376E/F* Screw terminals M10 Delta connection Coming soon</p> 	 <table border="1"> <caption>Approximate data for B32376E/F*</caption> <thead> <tr> <th>Capacitance (μF)</th> <th>V_{RMS} (V)</th> </tr> </thead> <tbody> <tr><td>50</td><td>1000</td></tr> <tr><td>100</td><td>900</td></tr> <tr><td>150</td><td>850</td></tr> <tr><td>200</td><td>780</td></tr> <tr><td>300</td><td>720</td></tr> <tr><td>400</td><td>660</td></tr> <tr><td>500</td><td>600</td></tr> <tr><td>600</td><td>530</td></tr> <tr><td>800</td><td>480</td></tr> <tr><td>1000</td><td>420</td></tr> </tbody> </table>	Capacitance (μF)	V _{RMS} (V)	50	1000	100	900	150	850	200	780	300	720	400	660	500	600	600	530	800	480	1000	420
Capacitance (μF)	V _{RMS} (V)																						
50	1000																						
100	900																						
150	850																						
200	780																						
300	720																						
400	660																						
500	600																						
600	530																						
800	480																						
1000	420																						
<p>B32377E/F* Clamp terminals M5 & M6 Delta connections</p> 	 <table border="1"> <caption>Approximate data for B32377E/F*</caption> <thead> <tr> <th>Capacitance (μF)</th> <th>V_{RMS} (V)</th> </tr> </thead> <tbody> <tr><td>50</td><td>1000</td></tr> <tr><td>100</td><td>900</td></tr> <tr><td>150</td><td>850</td></tr> <tr><td>200</td><td>780</td></tr> <tr><td>300</td><td>720</td></tr> <tr><td>400</td><td>660</td></tr> <tr><td>500</td><td>600</td></tr> <tr><td>600</td><td>530</td></tr> <tr><td>800</td><td>480</td></tr> <tr><td>1000</td><td>420</td></tr> </tbody> </table>	Capacitance (μF)	V _{RMS} (V)	50	1000	100	900	150	850	200	780	300	720	400	660	500	600	600	530	800	480	1000	420
Capacitance (μF)	V _{RMS} (V)																						
50	1000																						
100	900																						
150	850																						
200	780																						
300	720																						
400	660																						
500	600																						
600	530																						
800	480																						
1000	420																						
<p>B32378E/F* Clamp terminals (M5) Star connection Coming soon</p> 	 <table border="1"> <caption>Approximate data for B32378E/F*</caption> <thead> <tr> <th>Capacitance (μF)</th> <th>V_{RMS} (V)</th> </tr> </thead> <tbody> <tr><td>50</td><td>1000</td></tr> <tr><td>100</td><td>900</td></tr> <tr><td>150</td><td>850</td></tr> <tr><td>200</td><td>780</td></tr> <tr><td>300</td><td>720</td></tr> <tr><td>400</td><td>660</td></tr> <tr><td>500</td><td>600</td></tr> <tr><td>600</td><td>530</td></tr> <tr><td>800</td><td>480</td></tr> <tr><td>1000</td><td>420</td></tr> </tbody> </table>	Capacitance (μF)	V _{RMS} (V)	50	1000	100	900	150	850	200	780	300	720	400	660	500	600	600	530	800	480	1000	420
Capacitance (μF)	V _{RMS} (V)																						
50	1000																						
100	900																						
150	850																						
200	780																						
300	720																						
400	660																						
500	600																						
600	530																						
800	480																						
1000	420																						

Technical data and specifications

Reference standards	IEC 61071-2017, UL 810 5th, GB/T 17702-2021, RoHS compliance
Rated frequency f_R	50/60 Hz
Voltage V_{RMS} (line to line)	Rated AC voltage V_N (line to line)
250	350
330	460
420	590
480	680
530	750
600	850
660	935
720	1020
780	1100
850	1200
900	1270
1000	1415

Test data

Voltage between terminals V_{TT}	$2.15 \cdot V_{RMS}$, 2 s
Voltage between terminals and Case V_{TC}	4000 V AC, 10 s

Reliability data

Lifetime expectancy (reference value) ¹	100,000 hours at 70 °C hotspot, rated voltage
Failure in time	100 FIT at 85°C hotspot, rated voltage

Climatic category 40/70/21 IEC60068-1

Storage temperature T_{stg}	-40 ... +70 °C
Minimum operation ambient temperature T_{min}	-40 °C
Maximum operation ambient temperature T_{max}	+70 °C
Damp Heat Test T_{test}	21 days @ 40°C, 93% RH
Maximum hot spot temperature in capacitor T_{HS}	+85 °C
Max. permissible altitude	2000 m above sea level

¹ Lifetime expectancy detail refer to Figure 17

Mechanical characteristics	
Max. torque (for bottom stud)	M12: 12 Nm Optional M16 for critical application
Max. torque (for terminals)	B32376 (M10): 10 Nm B32377 Type A, type B (M5): 2 Nm B32377 Type C (M6): 3.5 Nm B32378 (M5): 2 Nm
Max insertion and withdraw force (for fast-on terminal)	50 N
Installation position ²	Vertical with terminals upright
Approvals	
 B32375*, B32377 type A, series: UL File no.: E487229, CCN:CYWT2/8 B32377 type B and B32377 type C: UL File no.: E487229, CCN:CYWT2/8	UL 810, CSA C22.2, No 190, Max. 600 V _{RMS} (Line Voltage), 50/60Hz, “Protected”, 10K AFC, max. +70 °C
	UL 810, CSA C22.2, No 190, Max. 1000 V _{RMS} (Line Voltage), 50/60Hz, “Protected”, 10K AFC, max. +70 °C

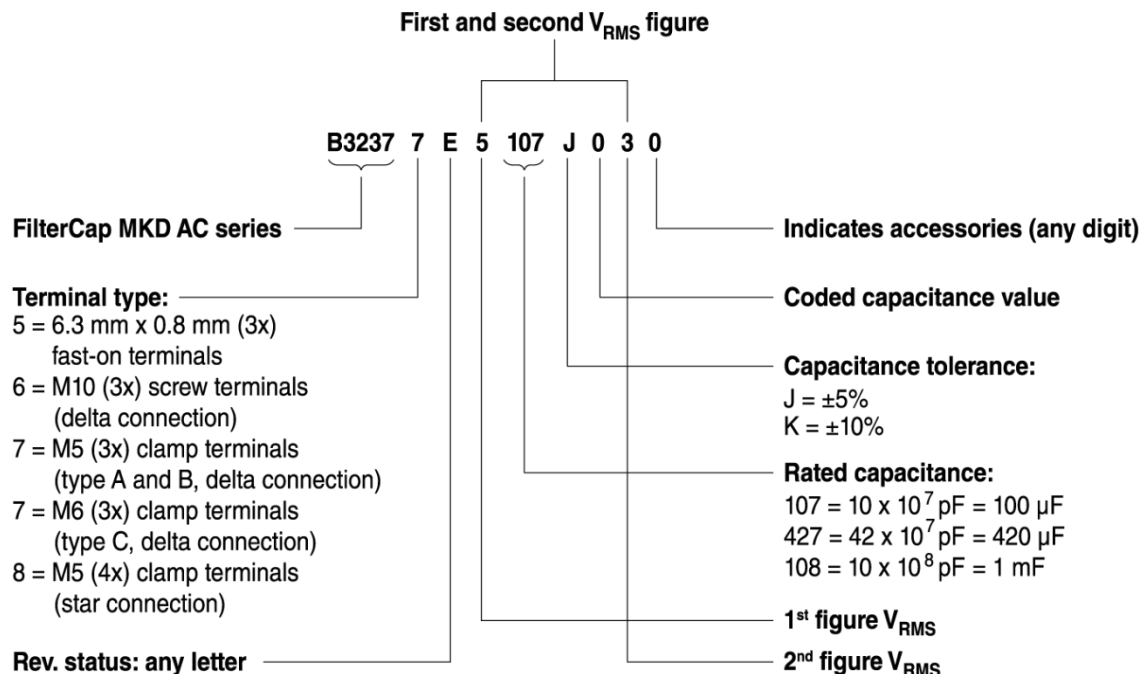
Structure of ordering code

² Capacitors are designed to be mounted with terminals upright. All tests during the approval of the series have been performed in vertical position. Capacitors can be also installed in horizontal position, however, since it might have an impact in performance it is highly recommended by us and it is customer duty to do the assessment on the electrical and mechanical performance with the customer mechanical design, under specific customer working condition.

Electrical characteristics

B32377* series - Clamp terminals

UL certification up to 1000 V_{RMS} (V_N /V_{RMS} line to line voltage)

V _N /V _{RMS} ³	C _R	Ordering code	I _{RMS,max} ⁴ at 70°C	I ⁴	R _{th} ⁵	R _S ⁶	tanδ ⁷	ESL ⁸	D	H	Terminal	Weight	Packing
V	μF		A	A	K/W	mΩ	×10 ⁻³	nH	mm	mm	type	kg	Unit
680/480	3 × 40	B32377F4406J080	22	1200	3.8	1.3	3.0	130	75	200	A	1.0	6
	3 × 80	B32377F4806J080	22	1550	2.7	1.4	6.0	150	85	275	A	1.8	4
	3 × 100	B32377F4107J080	27	1930	2.3	0.9	6.0	130	96	275	A	2.2	4
	3 × 130	B32377E4137J080	34	2980	1.9	0.6	5.5	130	116	259	B	3.0	4
	3 × 150	B32377E4157J080	50 ⁹	2900	1.9	0.7	7.0	130	116	289	B	3.2	4
	3 × 200	B32377E4207J080	59 ⁹	4590	1.7	0.5	7.5	130	136	259	B	3.9	4
750/530	3 × 20	B32377F5206J030	23	930	4.2	1.4	2.0	130	75	163	A	0.8	6
	3 × 25	B32377F5256J030	25	980	3.8	1.3	2.0	150	75	200	A	1.0	6
	3 × 30	B32377F5306J030	24	900	3.5	1.4	2.5	150	75	230	A	1.2	6
	3 × 50	B32377F5506J030	29	1680	2.7	1.0	2.5	100	96	206	B	1.7	4
	3 × 75	B32377E5756J030	38	2530	2.1	0.5	3.5	100	116	214	B	2.5	4
	3 × 100	B32377E5107J030	29	2770	2.0	0.8	5.0	100	116	244	B	2.8	4
	3 × 133	B32377E5137J330	39	3720	1.6	0.5	5.0	130	136	259	B	3.9	4
1200/850	3 × 55.8	B32377E8566J050	28	2630	1.7	0.5	3.0	150	136	238	C	3.7	4

Display of ordering codes for TDK Electronics products

The ordering code for one and the same product can be represented differently in data sheets, data books, other publications, on the company website, or in order-related documents such as shipping notes, order confirmations and product labels. **The varying representations of the ordering codes are due to different processes employed and do not affect the specifications of the respective products.** Detailed information can be found on the Internet under www.tdk-electronics.tdk.com/orderingcodes

³ V_N Rated AC Voltage (line to line)/V_{RMS} (line to line), complete explanation in the section Terms

⁴ Max permissible I_{RMS,max} current for T_{HS} ≤ +85 °C, ΔT_{max} ≤ 15K, considering a harmonic spectrum up to 10kHz. I_{RMS,max} derating vs temperature refer to the *Permissible current versus ambient temperature curve*

⁵ Thermal resistance ambient to HS, considering natural convection (10W/(m².K)), terminals without temperature fixation and bottom screw connected to a piece with big thermal inertia

⁶ Series resistance, R_S, is a typical value, model schematic refers to Figure 15

⁷ Max tan δ at 1 kHz

⁸ ESL at 1 MHz (typical value)

⁹ Climatic category 40/60/21. Max. current given at 60°C ambient.

Electrical characteristics: Clearance and creepage distances

Series	Diameter D mm	Max. height H _{max} mm	Terminal to terminal		Terminal to case	
			Min. clearance mm	Min. creepage mm	Min. clearance mm	Min. creepage mm
B32375 Type A	50/63.5	185	9.5	12.7	8.0	12.7
B32376	116	350	19.1	19.1	19.1	19.1
B32377 Type A	75/85/96/116/136	350	14.0	14.0	17.0	18.0
B32377 Type B	96/116/136	356	13.0	13.0	19.1	19.1
B32377 Type C	116/136	350	19.1	19.1	19.1	19.1
B32378 Type D	116/136	356	14.0	14.0	18.0	19.1
B32378 Type E	116/136	356	19.1	19.1	19.1	19.1

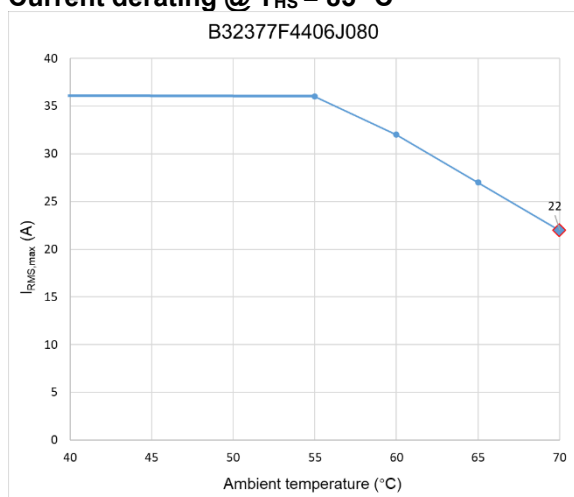
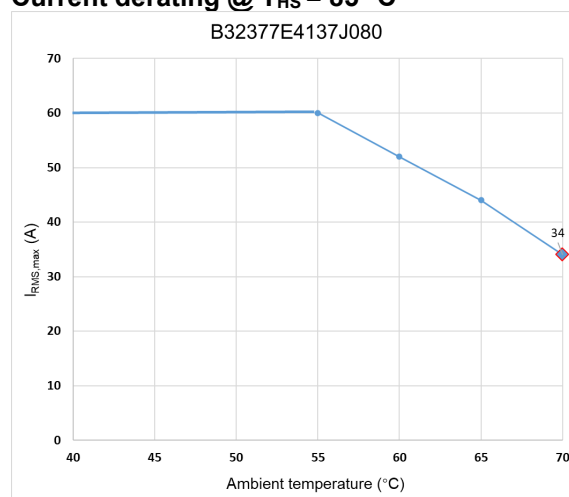
Permissible current versus ambient temperature curve
B32377F4406J080
Current derating @ T_{HS} = 85 °C

B32377E4137J080
Current derating @ T_{HS} = 85 °C

B32377E4157J080

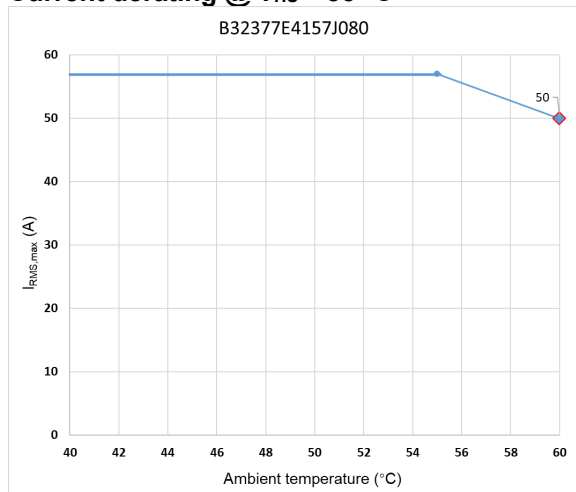
Current derating @ $T_{HS} = 85\text{ }^{\circ}\text{C}$



B32377E4207J08

Current derating @ $T_{HS} = 85\text{ }^{\circ}\text{C}$

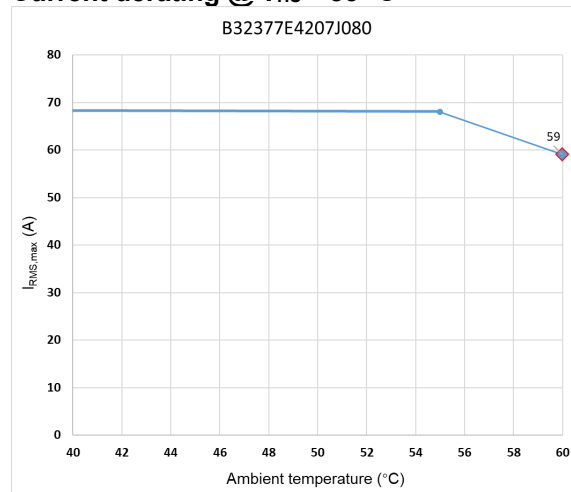

B32377E5107J030

Current derating @ $T_{HS} = 85\text{ }^{\circ}\text{C}$

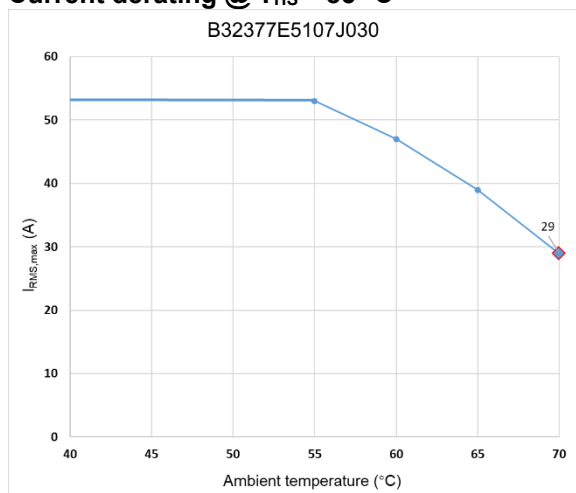

B32377E8556J050

Current derating @ $T_{HS} = 85\text{ }^{\circ}\text{C}$

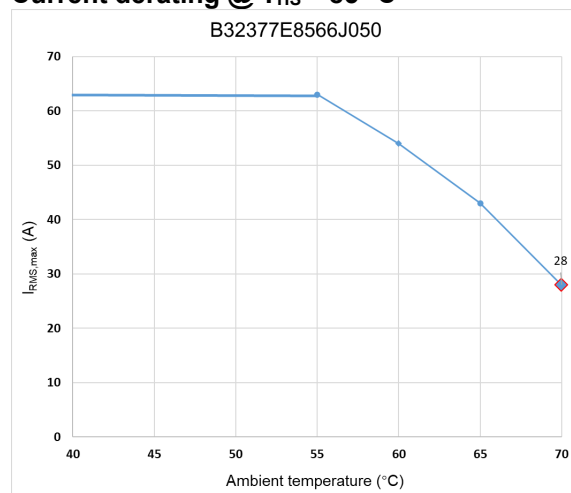

Permissible current versus ambient temperature curve for other types upon request.

Label Information:

B32377E5107J030

3x100μF Δ ±5%

V_{RMS} 530V~

V_N 750V~

I_s 8.3kA

IEC 61071 50/60Hz
 No PCB -40...+70°C
 Overpressure disconnecter SH
 Protected 10K AFC UL File E487229
 Maximum torque of terminals (B): 2Nm
 Discharge capacitor before handling
 Made by TDK 09 Z 2023



123456789001

Date code explanation

WW Z YYYY: production week (e.g.: CW:09)
WW Z YYYY: produced in Zhuhai (China)
WW Z YYYY: production year (e.g.: 2023)

Bar code explanation

Bar code consists of batch number and serial number.
 Batch number: 9 digits (e.g.: 123456789)
 Serial number: 3 digits (e.g.: 001)

Terminal type explanation

Terminals (A): type A terminals
 Terminals (B): type B terminals
 Terminals (C): type C terminals
 Terminals (D): type D terminals
 Terminals (E): type E terminals

Dimensional drawings

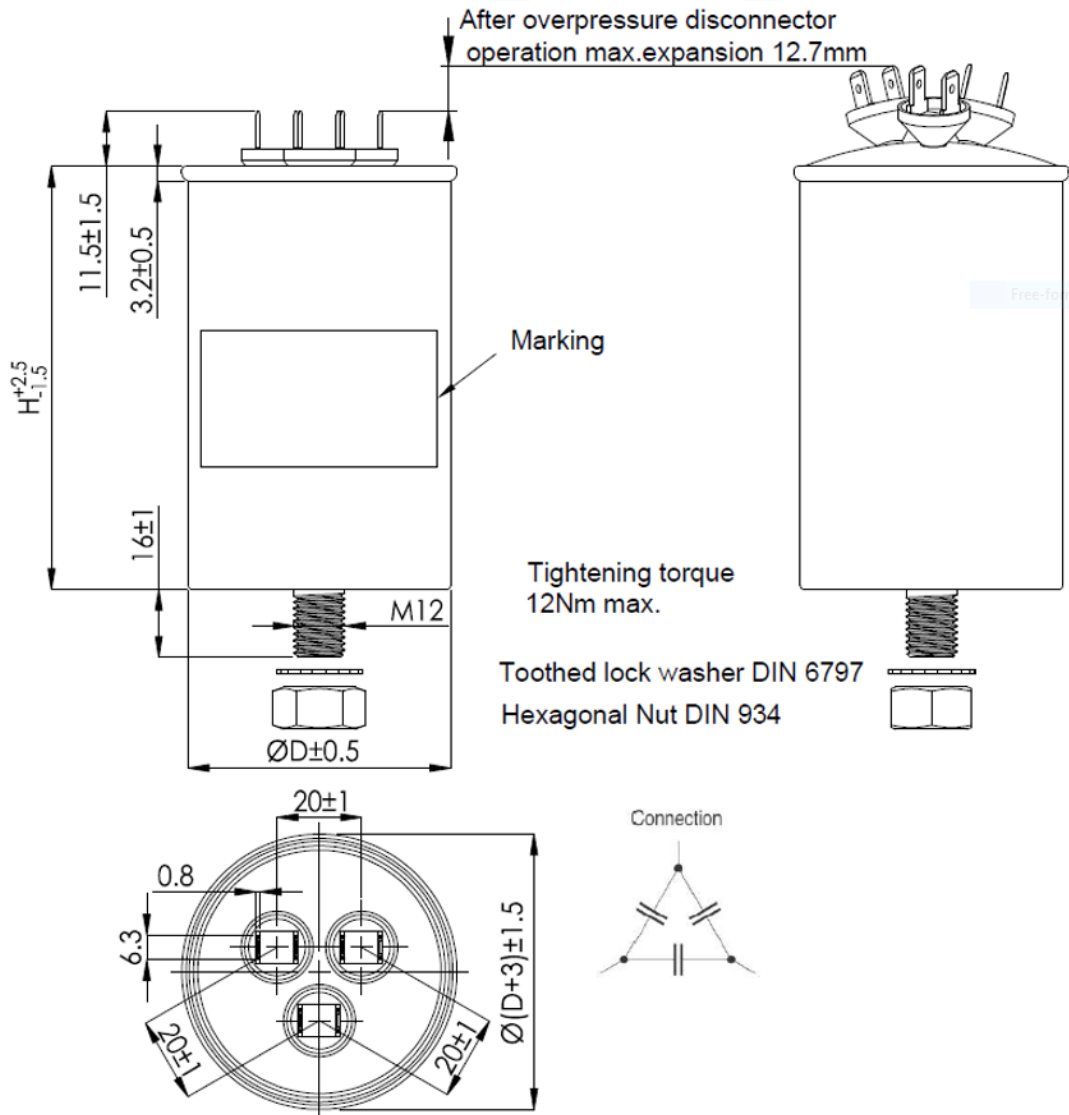

Figure 1: Series B32375* –fast-on terminal type A, delta connection

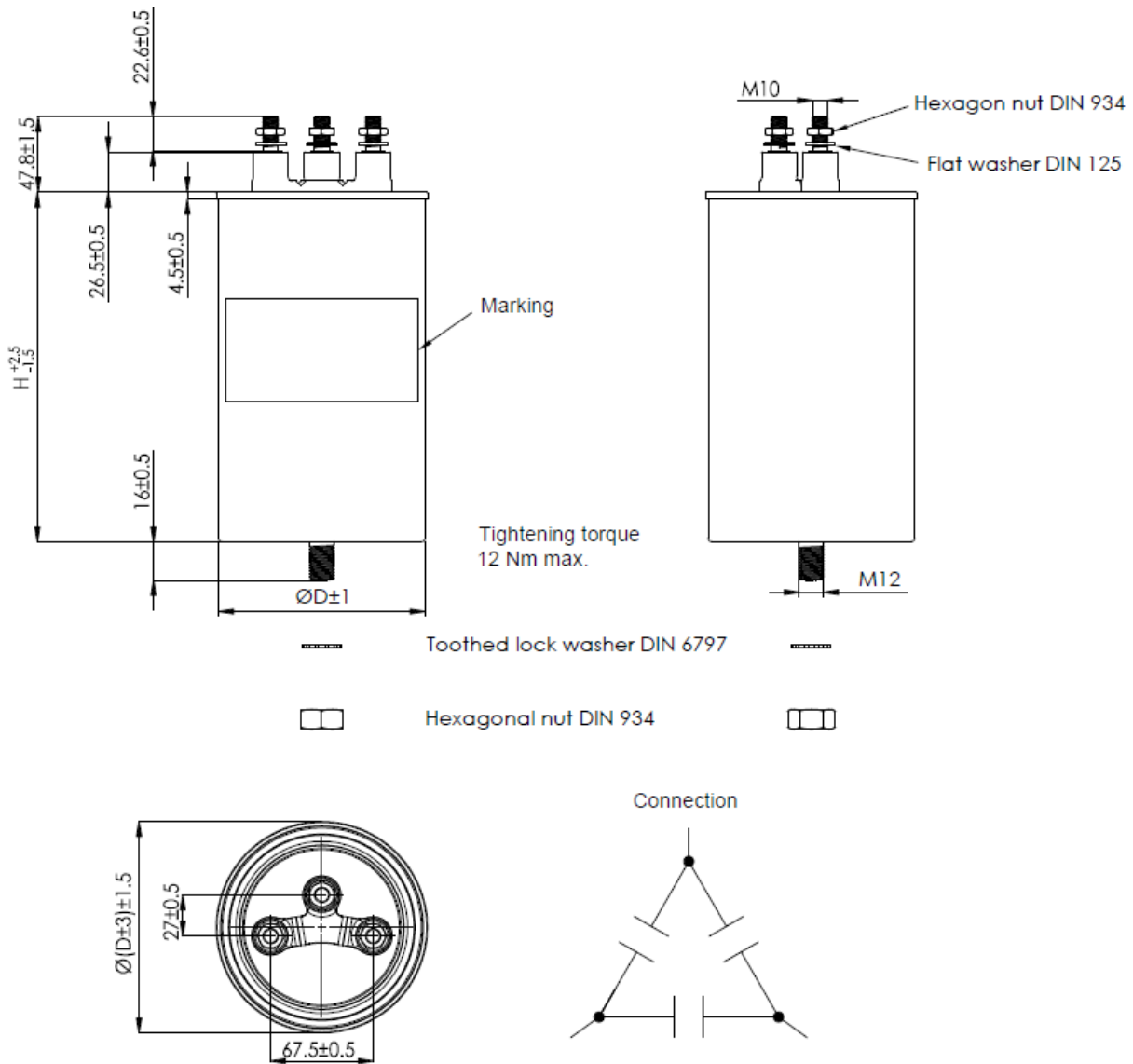

Figure 2: Series B32376* –M10 screw terminal type, delta connection

Dimensional drawings

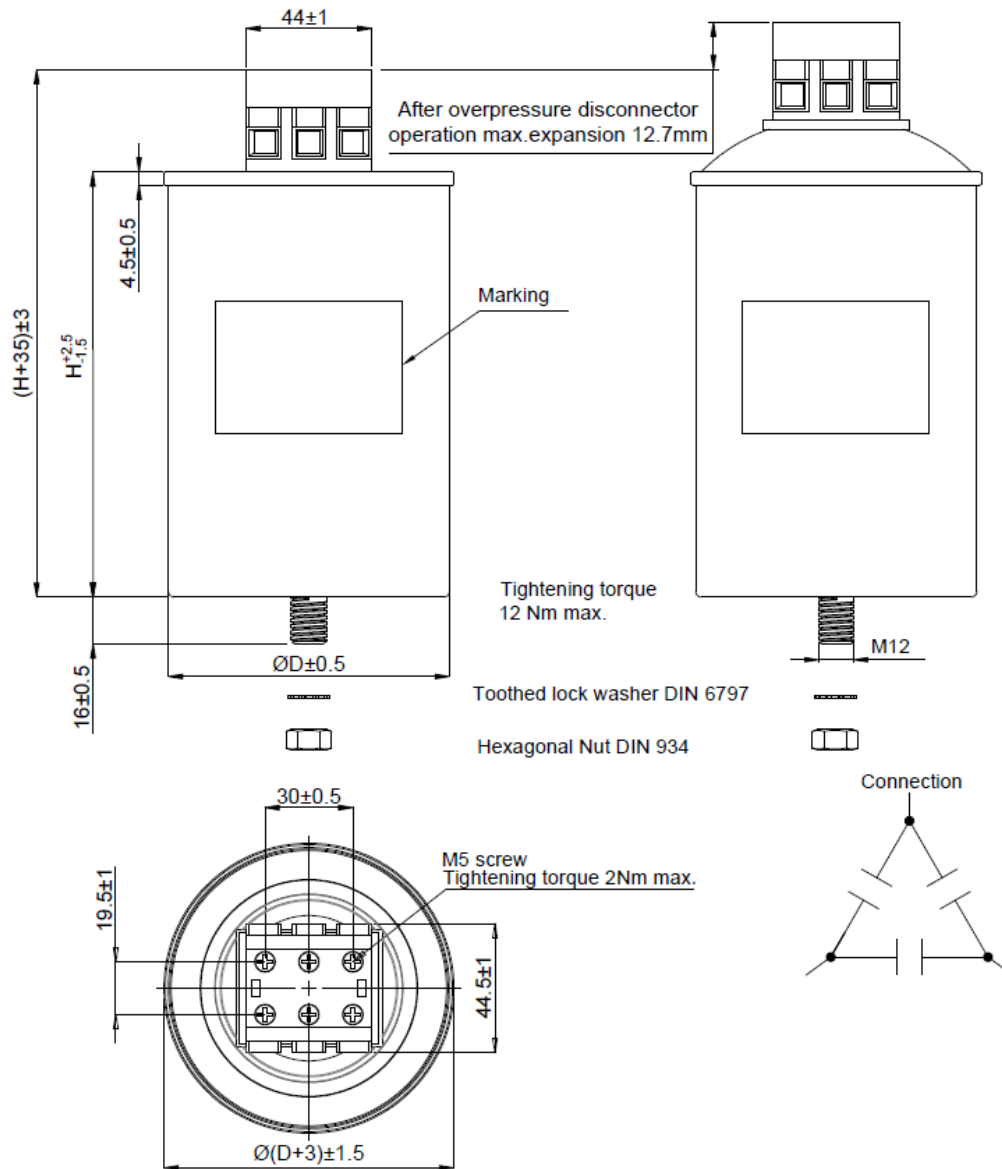

Figure 3: Series B32377* – M5 clamp terminal type A, delta connection

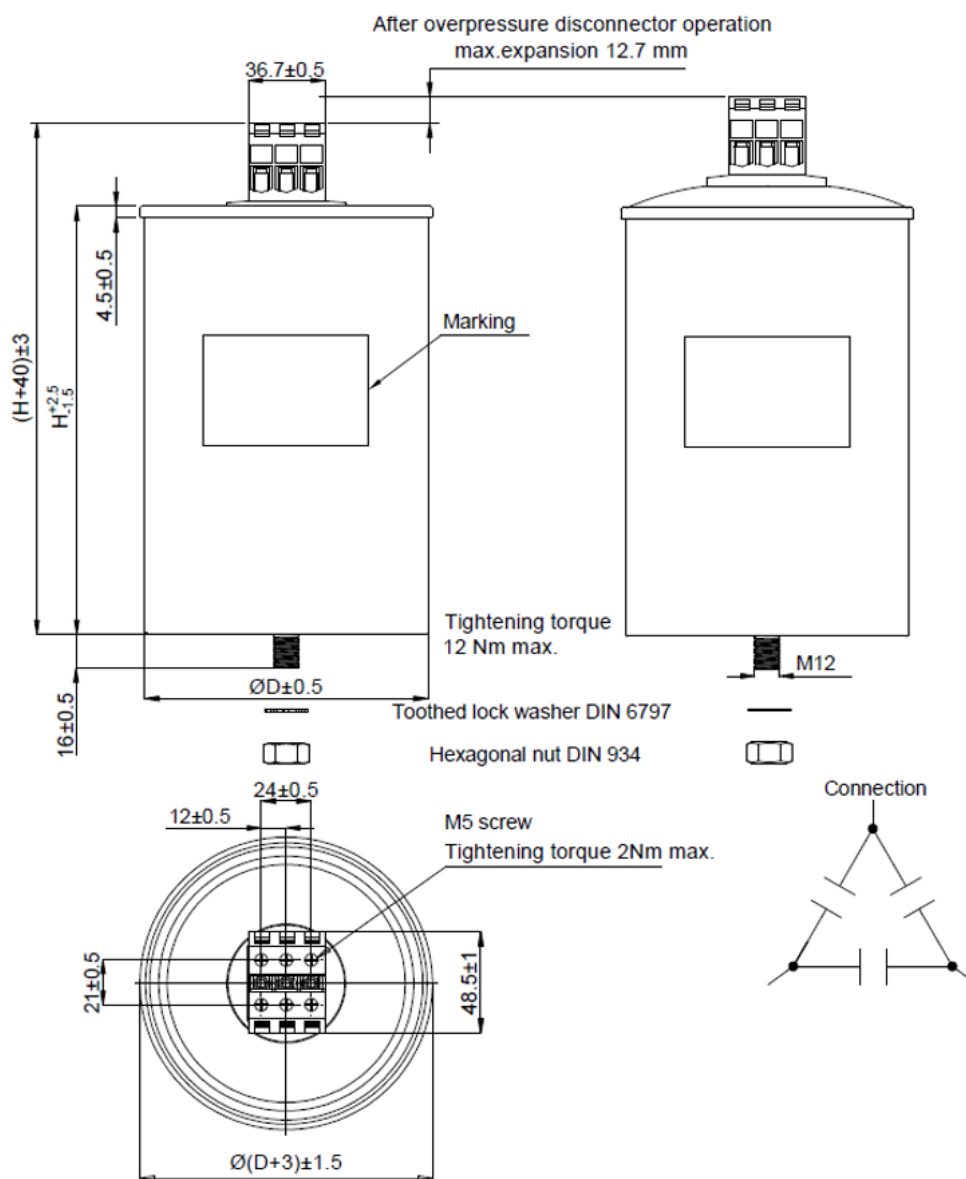

Figure 4: Series B32377* – M5 clamp terminal type B, delta connection

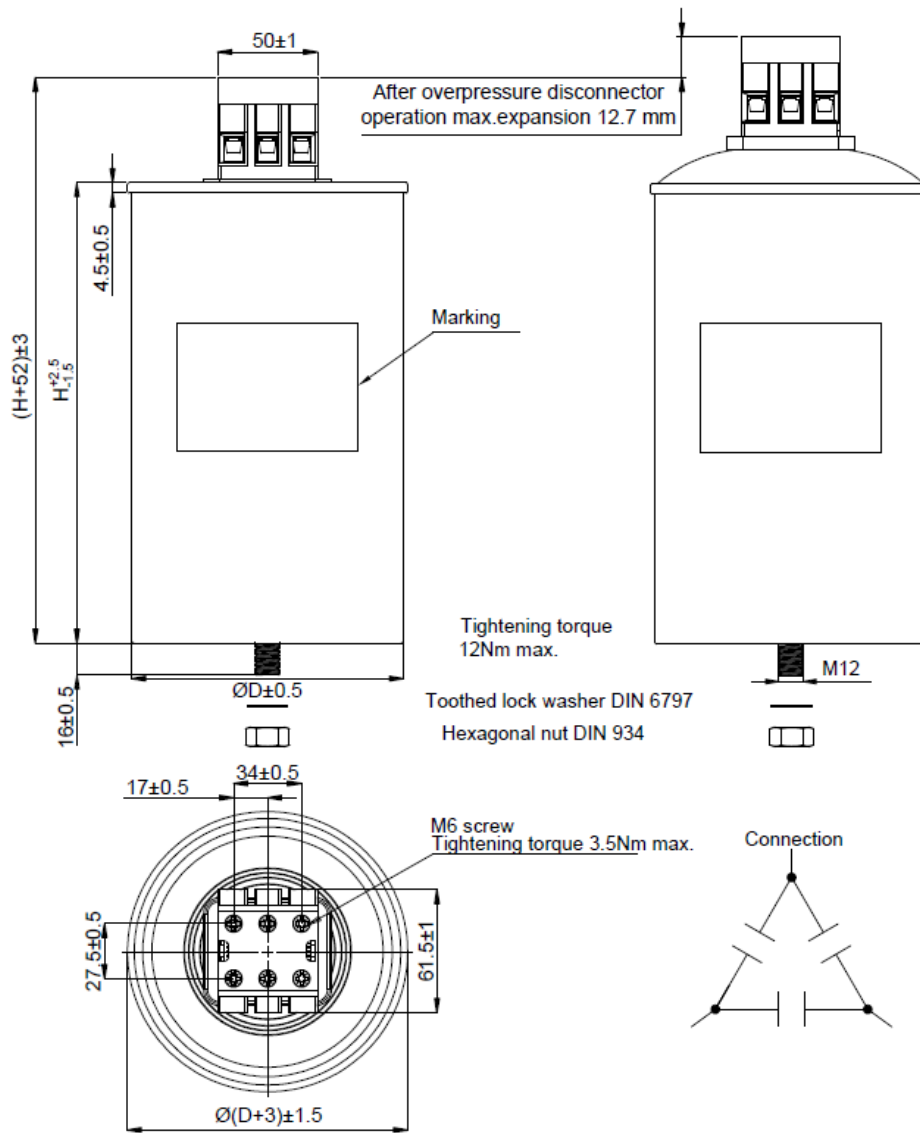

Figure 5: Series B32377* – M6 clamp terminal type C, delta connection

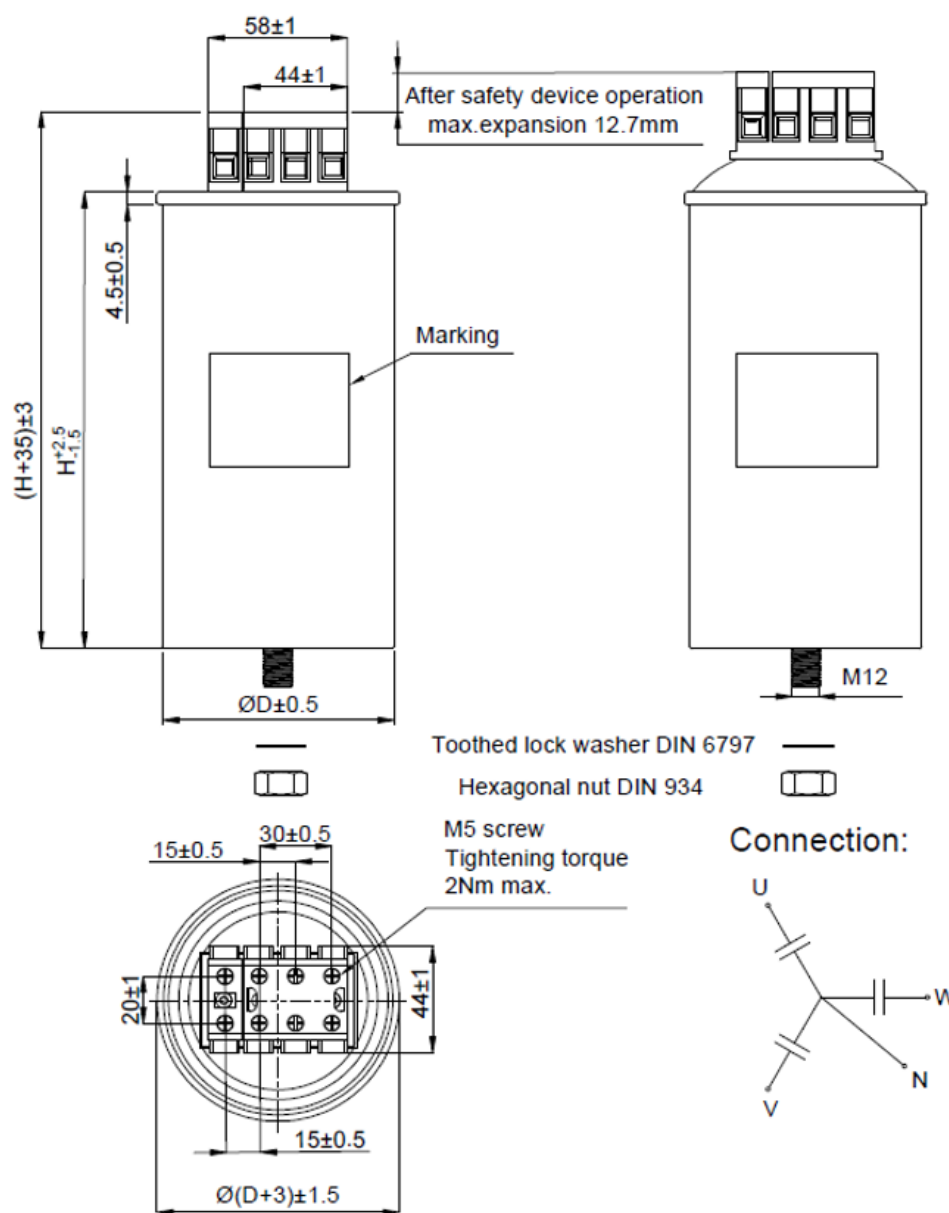

Figure 6: Series B32378* – M5 clamp terminal type D, star connection with neutral

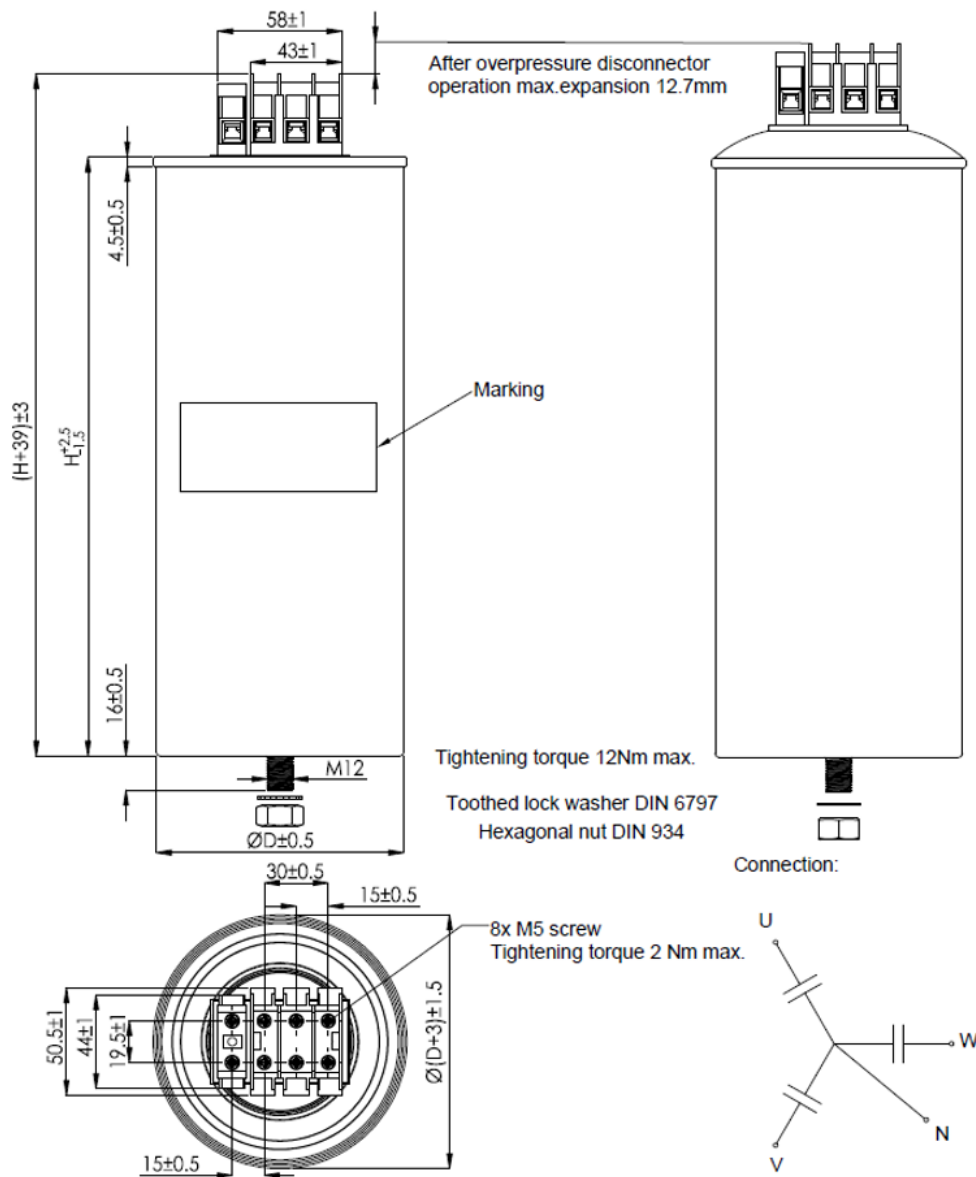

Figure 7: Series B32378* – M5 clamp terminal type E, star connection with neutral

Terms

Design

The winding element of the MKD capacitor consists of metallized polypropylene film. This winding construction achieves low losses and a high pulse-current withstand capability. Soft PU resin is used for impregnation of the capacitor.

Contacting

The end faces of the windings are contacted by metal spraying to ensure a reliable and low-inductance connection between the leads and layers. The leads are welded or soldered to these end faces, brought out through insulating elements (plastic) and soldered to the terminals.

Filler material

All hollows between the windings and between the windings and the case are filled with a fluid. Besides increasing dielectric strength, this improves heat dissipation from inside a capacitor. The filler material that we use is free of PCB and halogens.

Self-healing

All MKD capacitors are self-healing, i.e. voltage breakdowns heal in a matter of microseconds and hence do not produce a short circuit.

Breakdowns can occur under heavy electrical load as a result of weaknesses or pores in the dielectric. The integrity of self-healing capacitors is not affected by such breakdowns.

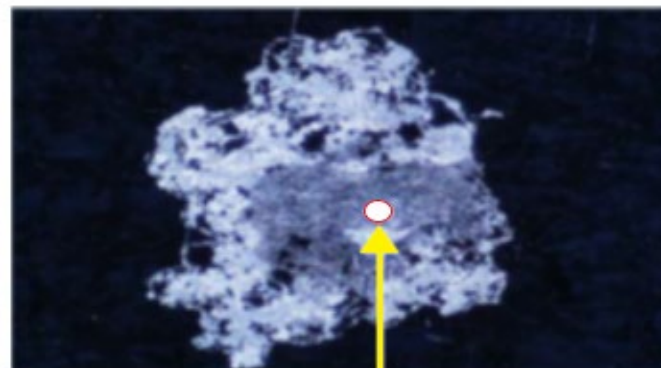
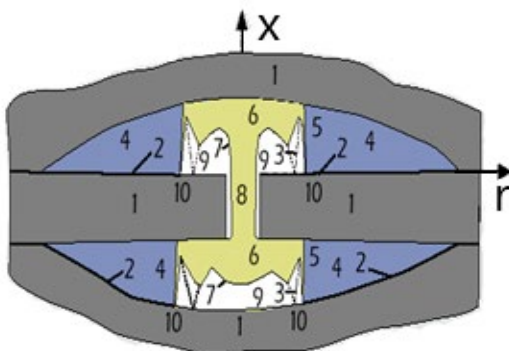

Breakdown

- | | |
|---|---|
| <ul style="list-style-type: none"> 1. Dielectric (Polypropylene) 2. Metallization 3. Material-displacing shock wave 4. Air gap with metal vapor 5,6. Plasma zone | <ul style="list-style-type: none"> 7. Boundary layer between gas-phase dielectric and plasma zones 8. Puncture channel 9. Gas-phase dielectric 10. Zone of displaced metallization and dielectric |
|---|---|

Figure 8: Description of self-healing technology

When a breakdown occurs, the dielectric in a breakdown channel is broken down into its atomic components by the electric arc that forms between the electrodes. At the high temperatures of as much as 6000 K, a plasma is created that explodes out of the channel region and pushes the dielectric layers apart. The actual self-healing process starts with the continuation of the electric arc in the propagating plasma. Here the metal layers are removed from the metal edges by evaporation. Insulation areas are formed. The rapid expansion of the plasma beyond the areas of insulation and its cooling in the areas of less field strength allow the discharge to extinguish after a few microseconds.

The area of insulation that is created is highly resistive and voltage-proof for all operating requirements of the capacitor. The self-healing breakdown is limited in current and so it does not represent a short circuit. The self-healing process is so brief and low in energy that the capacitor also remains fully functional during the breakdown.

Characteristics

Equivalent circuit diagram

Any real capacitor can be modelled by the following schematic:

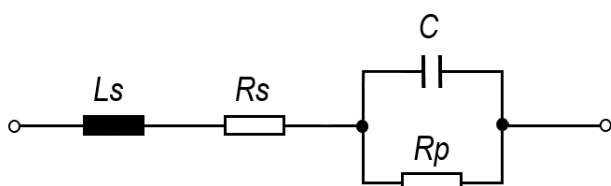

Figure 9: Equivalent circuit diagram

Symbol	Description	Unit
L_s	series inductance	H
R_s	series resistance, due to contacts (leads, sprayed metal and film metallization)	Ω
R_p	parallel resistance, due to insulation resistance	Ω
C	capacitance	F

C and L_s are magnitudes that vary in the frequency domain (AC).

R_p is a magnitude defined in DC (insulation resistance).

Rated capacitance C_R

It is referred to a test temperature of +20 °C and a measuring frequency range of 50 Hz to 1 kHz.

Capacitance tolerance range

It is the range within which the actual capacitance may differ from rated capacitance. The actual capacitance is to be measured at a temperature of +20 °C. This range results from variances in materials and manufacturing processes. The standard manufacturing tolerance for PP film capacitors is $\pm 10\%$ or 'K' tolerance or $\pm 5\%$, 'J' tolerance.

Temperature dependence of capacitance

The capacitance variation in the permissible temperature range is not linear, but it is reversible, the characteristic change in capacitance $\Delta C/C$ as a function of test temperature is shown as follows:

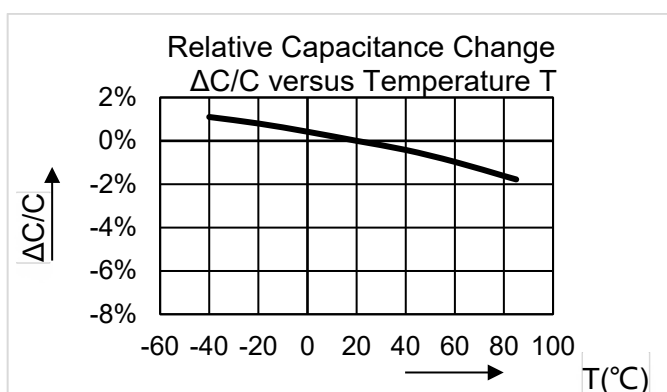

Figure 10: Temperature dependence of capacitance

Capacitance drift

Capacitance is subject to irreversible in addition to reversible changes, i.e. capacitance drift, the sum of all time-dependent, irreversible changes of capacitance during operating life. This variation is stated in percent of the value at delivery. The typical figure is +1/−3%.

Rated AC voltage V_N

The maximum operating peak recurrent voltage of either polarity of a reversing type waveform for which the capacitor has been designed.

Unlike what is common in other standard (e.g. B32304* 3-phase capacitor series for PFC application) the rated voltage V_N is not the RMS value, but the maximum or peak value of the capacitor voltage. The voltage at which the capacitor may be operated is dependent on other factors (especially current and frequency) besides rated voltage.

Voltage V_{RMS}

It is the Root Mean Square (RMS) voltage of maximum permissible value of sinusoidal AC voltage in continuous operation.

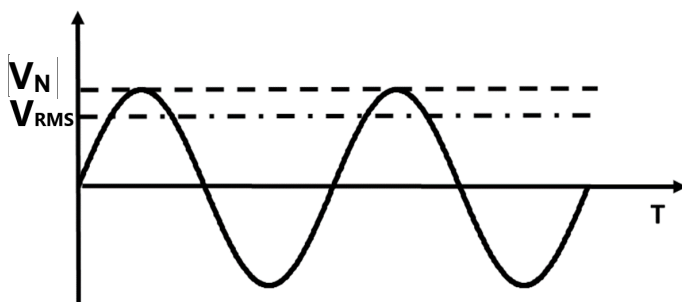

Figure 11: Voltage V_{RMS}

Non-recurrent surge voltage V_s

A peak voltage induced by a switching or any other disturbance of the system which is allowed for a limited number of times and for durations shorter than the basic period.

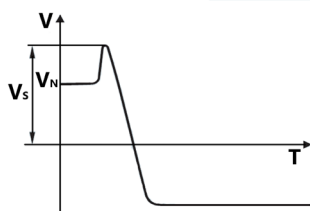

Figure 12: Non-recurrent surge voltage V_s

Maximum duration: 50 ms/pulse

Maximum number of occurrences: 1000 (during load)

Max. Recurrent peak voltage \hat{u}

This is the permissible, max. recurrent peak voltage that may appear for max.1% of the period.

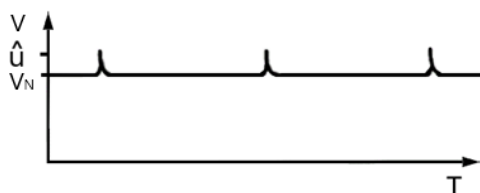

Figure 13: Max. Recurrent peak voltage \hat{u}

Symmetric alternating voltage \hat{u}_{ac}

The peak values of a symmetrical alternating voltage applied to the capacitor is a decisive factor for the dielectric losses.

$$\text{For AC capacitors: } \hat{u}_{ac} = V_N$$

Insulation voltage V_i

It is the RMS rated value of the insulation voltage of capacitive elements and terminals to case or earth. If not specified, the RMS value of the insulating voltage is equivalent to the rated voltage divided by $\sqrt{2}$.

Maximum current $I_{RMS,max}$

It is the maximum RMS current for continuous operation which, at rated temperature and for given harmonic distortion, will lead to a maximum hot-spot temperature (T_{HS}) of 85°C.

Note that RMS current with different harmonic distortions could generate different self-heating temperatures. A higher current than $I_{RMS,max}$ value could be possible if the hot-spot temperature (T_{HS}) is lower than 85 °C. On the contrary, same RMS current with more harmonic distortions at higher frequency could have higher self-heating temperature that makes T_{HS} higher than 85 °C (dangerous for capacitor). For that reason, **we strongly suggest end customers to qualify capacitor using samples with thermocouples (upon request) in order to verify the real operating temperature inside of capacitor under real application or to check with TDK company for detail discussions.**

Maximum peak current \hat{I}

It is the maximum current amplitude which occurs instantaneously during continuous operation. The maximum peak current and the maximum rate of voltage rise $(dV/dt)_{\max}$ on a capacitor are related as follows:

$$\hat{I} = C_R \cdot \left(\frac{dV}{dt} \right)_{\max}$$

Maximum surge current I_s

It is the peak non-repetitive current induced by switching or any other disturbance of the system permitted for a limited number of times, at durations shorter than the basic period.

$$I_s = C_R \cdot \left(\frac{dV}{dt} \right)_s$$

Maximum duration: 50 ms/pulse

Maximum number of occurrences: 1000 (during load)

Fault current (AFC)

It is a failure mode in which capacitor is intentionally internally faulted to represent dielectric breakdown that would occur within the capacitor over time.

The fault current test is intended to address protection of the capacitor from available fault currents over the life of the capacitor. The maximum fault current test levels represent a complete internal dielectric breakdown in the capacitor with the maximum fault current available. The lower fault current test levels represent the various stages of internal dielectric breakdown during the life of the capacitor where the available fault current will be less.

Self-inductance L_{self}

The self-inductance is produced by the inductance of the terminals and the windings. Because of the special kind of contacting in self-healing capacitors (large area metal spraying covering all windings), the self-inductance is particularly low. It allows the resonance frequency to be determined:

$$f = \frac{1}{2\pi\sqrt{L_{\text{self}} \cdot C_R}}$$

The resonance frequency is high for all capacitors accordingly.

Insulation Resistance (R_{ins})

The dielectric of a capacitor has a large area and a short length. Even if the material is a good isolator there always flows a certain current between the charged electrodes (the current increases exponentially with the temperature). This leakage can be described as a parallel resistance with a high value, an Insulation Resistance.

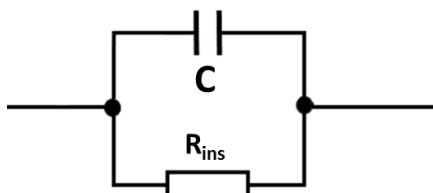

Figure 14: Insulation Resistance (R_{ins})

Insulation resistance and self-discharge time constant

The insulation values for the individual components according to the capacitance are stated as an insulation resistance R_{ins} in $M\Omega$ or a self-discharge time constant τ in seconds.

$$\tau = R_{ins} \cdot C_R$$

Series resistance R_s

Resistive losses occur in the electrodes in the contacting and in the inner wiring. These are comprised in the series resistance R_s of a capacitor.

The series resistance R_s generates the ohmic losses ($I^2 \times R_s$) in a capacitor. It is largely independent of frequency. The figures stated in selection charts apply to $+20^\circ\text{C}$ capacitor temperature.

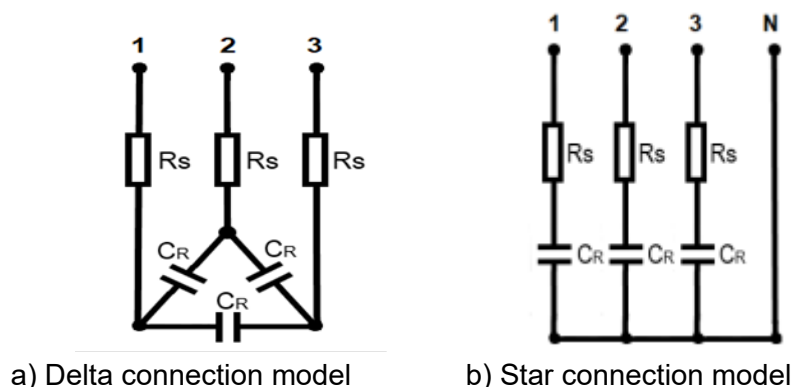

Figure 15: Resistance model of 3 Phase capacitor

Dissipation factor $\tan \delta$

The equivalent circuit diagram used for the losses in a capacitor can be shown as follows:

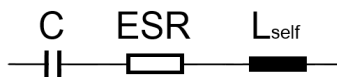

Figure 16: Simplified equivalent circuit diagram of a capacitor

Symbol	Description	Unit
C	Capacitor	F
L_{self}	Self-inductance	H
ESR	Equivalent series resistance, representing the entire active power in capacitor	Ω

The self-inductance and capacitance of a capacitor produce its resonance frequency (natural frequency).

$$\tan \delta(f) = \tan \delta_0 + R_s \cdot \omega \cdot C$$

From the frequency dependence of the equivalent series resistance can be derived:

$$ESR = \frac{\tan \delta}{\omega \cdot C} = R_s + \frac{\tan \delta_0}{\omega \cdot C}$$

Symbol	Description	Unit
$\tan \delta$	Dissipation factor of capacitor	-
$\tan \delta_0$	Dissipation factor of dielectric	-
R_s	Series resistance	Ω

Dielectric dissipation factor $\tan \delta_0$

The dissipation factor $\tan \delta_0$ of the dielectric is assumed to be constant for all capacitors in their frequency range of use. The figures stated in data sheets apply to rated operation.

Expected FIT rate λ

The FIT (Failure In Time) of a component is defined as the number of expected failures in 10^9 hours of operation.

The FIT rate is calculated on the basis of the number of components operating in the field and the estimated hours of operation. Field failure information is taken into consideration for this calculation which is updated every year.

Thermal design

In order to scale a capacitor correctly for a particular application, the permissible ambient temperature versus maximum current must be determined as explained along this chapter.

Introducing power dissipation (P) and thermal resistance (R_{th}) concepts are required for this estimation.

Calculation of power dissipation P

At each frequency the power dissipation P is composed of the dielectric losses (P_D) and the resistive losses (P_R).

Generally, a secondary sinusoidal AC voltage can be used for calculating with sufficient accuracy, besides fundamental frequency.

$$P(f_i) = P_D(f_i) + P_R(f_i)$$

Which can be also calculated as:

$$P(f_i) = I(f_i)^2 \cdot ESR(f_i)$$

Dielectric losses (P_D) at each frequency f_i can be calculated as follows:

$$P_D(f_i) = V(f_i)^2 \cdot 2\pi \cdot f_i \cdot C \cdot \tan \delta_0 = \frac{I(f_i)^2}{2 \cdot \pi \cdot f_i \cdot C} \cdot \tan \delta_0$$

Symbol	Description	Unit
V(f_i)	RMS voltage at frequency f_i applied to capacitor	V
I(f_i)	RMS current at frequency f_i applied to capacitor	A
f_i	Frequency	Hz
C	Capacitance	F
$\tan \delta_0$	Dissipation factor of dielectric	-

Note: value of dielectric losses (P_D) at frequencies much higher than fundamental frequency are negligible.

Resistive losses (P_R) at each frequency f_i can be calculated as follows:

$$P_R(f_i) = I(f_i)^2 \cdot R_s$$

Symbol	Description	Unit
I(f_i)	RMS current at frequency f_i applied to capacitor	A
R_s	Series resistance	Ω

The total power dissipation P will be:

$$P = \sum_i [P_D(f_i) + P_R(f_i)]$$

Which can be also simplified as follows:

$$P = P_D(f_0) + \sum_i P_R(f_i) = (V_{RMS}^2 \cdot 2\pi \cdot f_0 \cdot C \cdot \tan \delta_0) + (I^2 \cdot R_s)$$

Or alternatively:

$$P = \sum_i [I(f_i)^2 \cdot ESR(f_i)]$$

Symbol	Description	Unit
V_{RMS}	RMS voltage at fundamental frequency f_0 applied to capacitor	V
I	Total RMS current applied to capacitor	A
f_0	Fundamental frequency	Hz
C	Capacitance	F
$ESR(f_i)$	Equivalent Series Resistance at frequency f_i	Ω
$\tan \delta_0$	Dissipation factor of dielectric	-

Thermal resistance R_{th}

The thermal resistance is defined as the ratio of a temperature difference and the power dissipation produced in a capacitor. The decisive factor here is ΔT where the temperature difference between an external reference point of the coolant (e.g. air) surrounding the capacitor and the hot spot (zone with highest temperature occurring in the component). In a steady state:

$$R_{th} = \frac{\Delta T}{P}$$

Symbol	Description	Unit
R_{th}	Thermal resistance (ambient to hot-spot)	K/W
ΔT	Temperature difference between hot-spot and ambient	K
P	Power dissipation	W

Thermal design: Estimation of hot-spot temperature in capacitor (T_{HS})

As a basic rule of thermal design, hot-spot can never exceed a maximum temperature of 85 °C, what means:

$$T_{HS} = T_{amb} + \Delta T = T_{amb} + (P \cdot R_{th}) \leq 85 \text{ °C}$$

Symbol	Description	Unit
T_{amb}	Ambient temperature around capacitor	°C
ΔT	Temperature difference between hot-spot temp. and ambient	K
P	Power dissipation	W
R_{th}	Thermal resistance (ambient to hot-spot)	K/W

Else, maximum currents can be taken from the diagram of *Permissible current versus ambient temperature*.

Thermal design example

Capacitor electrical parameters		
Reference	B32373F7686J080	
V_{RMS}	780	V (50Hz)
$I_{RMS,max}$	37	A (70°C)
Capacitance	68	µF
R_s	1.6	mΩ
R_{th}	2.8	K/W
$\tan \delta_0$	0.0002	-

Operating conditions		
V_{RMS}	780	V (50Hz)
Fundamental frequency (f_0)	50	Hz
Ripple frequency (f_1)	8,000	Hz
I_{RMS} total	21	A
T_{amb}	40	°C

1) Verification of initial requirements

- a. I_{RMS} total = 21 A ≤ 37 A
- b. V_{RMS} = 780 V ≤ 780 V

2) Estimation of T_{HS}

$$I_0(50 \text{ Hz}) = 780 \cdot 2\pi \cdot 50 \cdot 68 \cdot 10^{-6} = 16.7A$$

$$I_1(8 \text{ kHz}) = \sqrt{21^2 - 16.7^2} = 12.7A$$

$$P_D(50 \text{ Hz}) = 780^2 \cdot 2\pi \cdot 50 \cdot 68 \cdot 10^{-6} \cdot 0.0002 = 2.598 \text{ W}$$

$$P_D(8 \text{ kHz}) = \frac{12.7^2}{2 \cdot \pi \cdot 8,000 \cdot 68 \cdot 10^{-6}} \cdot 0.0002 = 0.009 \text{ W}$$

$$P_R(50 \text{ Hz}) = 16.7^2 \cdot 0.0016 = 0.446 \text{ W}$$

$$P_R(8 \text{ kHz}) = 12.7^2 \cdot 0.0016 = 0.258 \text{ W}$$

$$P = 2.598 + 0.009 + 0.446 + 0.258 = 3.311 \text{ W}$$

$$\Delta T = P \cdot R_{th} = 3.311 \cdot 2.8 = 9.3 \text{ K}$$

$$T_{HS} = T_{amb} + \Delta T = 40 + 9.3 = 49.3 \text{ }^\circ\text{C} \leq 85 \text{ }^\circ\text{C}$$

Lifetime Expectancy Graphs

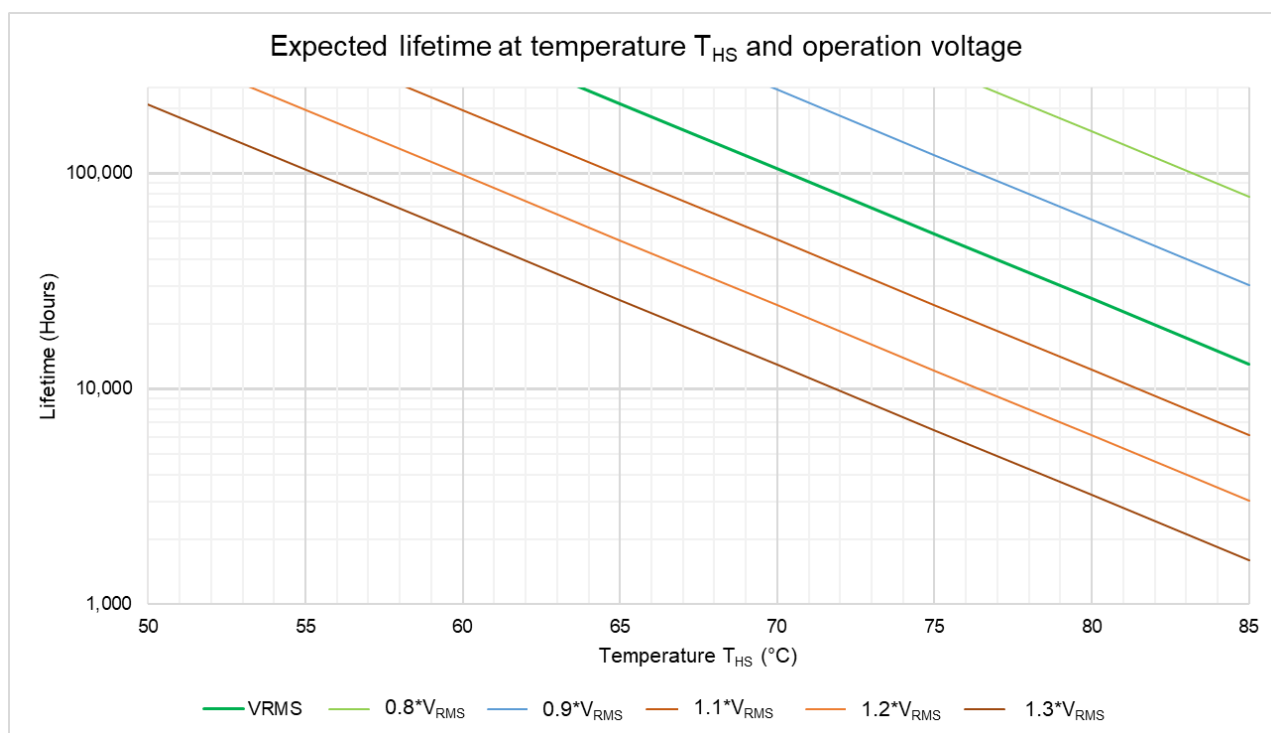

Figure 17: Expected lifetime in hours at different hotspot temperatures (T_{HS}) and voltages V_{RMS} .

Lifetime estimations are typical values derived from lifetime tests based on TDK internal standards or mutually agreed test methods and are intended for guidance purposes only. The useful life does not constitute a warranty of any kind or a prolongation of the agreed warranty period.

Cautions and Warnings

General

- In case of dents of more than 1 mm depth or any other mechanical damage, capacitors must not be used at all.
- Check tightness of the connections/terminals periodically.
- The energy stored in capacitors may be lethal. To prevent any chance of shock, discharge and short-circuit the capacitor before handling.
- Failure to follow cautions may result, worst case, in premature failures, bursting and fire.
- Protect the capacitor properly against over current and short circuit.
- TDK Electronics is not responsible for any kind of possible damages to persons or objects due to improper installation and application of capacitors for power electronics.

Safety

- Electrical or mechanical misapplication of capacitors may be hazardous. Personal injury or property damage may result from bursting of the capacitor or from expulsion melted material due to mechanical disruption of the capacitor.
- Ensure good, effective grounding for capacitor enclosures.
- Observe appropriate safety precautions during operation (self-recharging phenomena and the high energy contained in capacitors).
- Handle capacitors carefully, because they may still be charged even after disconnection.
- The terminals of capacitors, connected bus bars and cables as well as other devices may also be energized after disconnecting.
- Follow good engineering practices.
- When power capacitors are used, suitable measures must always be taken to eliminate possible danger to humans, animals and property both during operation and when a failure occurs. This applies to capacitors both with and without protective devices. Regular inspection and maintenance by trained personnel is therefore essential
- The maximum permissible fault current (AFC) of 10 kA in accordance with the UL 810 standard must be assured by the application.

Handling

Do not handle the capacitor before it is discharged! When handling the capacitor, do not take the capacitor from the terminal. This can cause accidents in case the capacitor is charged and additionally the terminal could break.

Thermal load

After installation of the capacitor it is necessary to verify that the maximum hot-spot temperature is not exceeded at extreme service conditions.

Installation

Capacitors must be installed in a cool and well-ventilated place, away from objects that radiate heat, or from direct sunlight. Within high-power inverter systems the capacitors usually produce the smallest portion of the total losses, and the permissible operating temperatures are low compared to power semiconductors, reactors and resistors. So, the distance between capacitor and heating sources must be far enough to prevent the capacitor from overheating. In case of space constraint to

CAP PW PD

2023-08-21

Cautions and Warnings

make the best possible use of capacitors, technically and economically, it is advisable to supply forced cooling air.

Mechanical protection

The capacitor has to be installed in a way that mechanical damages and dents in the aluminum can be avoided.

Connecting

Ensure firm fixing of terminals, fixing torque to be applied as per individual specification.

In any case, the maximum specified terminal current may not be exceeded. Please refer to the technical data of the specific series.

Grounding

The threaded bottom stud of the capacitor must be used for grounding. In case grounding is done via metal chassis where the capacitor is mounted on, the layer of varnish beneath the washer and nut should be removed. In case, capacitor with plastic case, this is not applicable. Ensure the tightening torque does not exceed the specified limit.

Maintenance recommendation

Disregarding the following measures may result in severe operation failures, bursting and fire:

- Check tightness of the connections/terminals periodically.
- Clean the terminals/bushings periodically to avoid short circuits due dust or other contamination.
- Ensure the current does not exceed the limit.
- In case of a current above the nominal current check your application for modification.
- Check the temperature of energized capacitors. In case of excessive temperature of individual capacitors, it is recommended to replace this capacitor, as this could be an indication for loss factor increase, which is a sign for reaching end of life.

Storage and operating conditions

Do not use or store capacitors in corrosive atmosphere, especially where chloride gas, sulfide gas, acid, alkali, salt or the like are present. In dusty environments regular maintenance and cleaning especially of the terminals is required to avoid conductive path between phases and/or phases and ground.

- Capacitors must not be stored in high temperatures and/or high humidity, we recommend the following storage conditions
 - Temperature between -40 °C ~ 40 °C
 - Humidity <= 80% RH as average per year
- Storage should not exceed 2 years (from the date code printed on the capacitor). After 1 year of storage time, capacitors must be checked electrically.

Overpressure disconnecter

To ensure full functionality of an overpressure disconnecter, the following must be observed:

Cautions and Warnings

1. The elastic elements must not be hindered, i.e.
 - Connecting lines must be flexible leads (cables)
 - There must be sufficient space (min.20 mm) for expansion above the connections
 - Metal cover must not be retained by rigid parts, like: bus bars.
2. Stress parameters of the capacitor must be within the IEC 61071-2017 specification.

NOTE 1 As the actual conditions can be significantly different in service, the behaviour at the end of life may also be different. Stored energy expected short-circuit current, duration of failure current (and so on) has to be considered in the application. Compliance with IEC61071-5.16 does not guarantee safe end of life of a capacitor.

NOTE 2 Successful completion of the IEC61071-5.16 test is not sufficient to guarantee the total safe failure of the components in service. For this reason, there is a residual risk of fire and/or explosions that has to be carefully taken in consideration.

Lifetime expectancy

As a rule, TDK Electronics is unfamiliar with individual customer applications or less familiar with them than the customers themselves. The results will not contain the various influences which might occur in respect to TDK products, when TDK products will be incorporated into the customer application. For these reasons, it is ultimately incumbent on the customer to check and decide whether an TDK product with the properties described in the product specification is suitable for use in a particular customer application.

We also point out that in individual cases a malfunction of electronic components or failure before the end of their usual service life cannot be completely ruled out in the current state of the art, even if they are operated as specified. In customer applications requiring a very high level of operational safety and especially in customer applications in which the malfunction or failure of an electronic component could endanger human life or health (e.g. in accident prevention or life-saving systems), it must therefore be ensured by means of suitable design of the customer application or other action taken by the customer (e.g. installation of protective circuitry or redundancy) that no injury or damage is sustained by third parties in the event of malfunction or failure of an electronic component.

|

Important notes

The following applies to all products named in this publication:

1. Some parts of this publication contain **statements about the suitability of our products for certain areas of application**. These statements are based on our knowledge of typical requirements that are often placed on our products in the areas of application concerned. We nevertheless expressly point out **that such statements cannot be regarded as binding statements about the suitability of our products for a particular customer application**. As a rule we are either unfamiliar with individual customer applications or less familiar with them than the customers themselves. For these reasons, it is always ultimately incumbent on the customer to check and decide whether a product with the properties described in the product specification is suitable for use in a particular customer application.
2. We also point out that **in individual cases, a malfunction of electronic components or failure before the end of their usual service life cannot be completely ruled out in the current state of the art, even if they are operated as specified**. In customer applications requiring a very high level of operational safety and especially in customer applications in which the malfunction or failure of an electronic component could endanger human life or health (e.g. in accident prevention or life-saving systems), it must therefore be ensured by means of suitable design of the customer application or other action taken by the customer (e.g. installation of protective circuitry or redundancy) that no injury or damage is sustained by third parties in the event of malfunction or failure of an electronic component.
3. **The warnings, cautions and product-specific notes must be observed.**
4. In order to satisfy certain technical requirements, **some of the products described in this publication may contain substances subject to restrictions in certain jurisdictions (e.g. because they are classed as hazardous)**. Useful information on this will be found in our Material Data Sheets on the Internet (www.tdk-electronics.tdk.com/material). Should you have any more detailed questions, please contact our sales offices.
5. We constantly strive to improve our products. Consequently, **the products described in this publication may change from time to time**. The same is true of the corresponding product specifications. Please check therefore to what extent product descriptions and specifications contained in this publication are still applicable before or when you place an order.

We also **reserve the right to discontinue production and delivery of products**. Consequently, we cannot guarantee that all products named in this publication will always be available. The aforementioned does not apply in the case of individual agreements deviating from the foregoing for customer-specific products.

6. Unless otherwise agreed in individual contracts, **all orders are subject to our General Terms and Conditions of Supply**.
7. **Our manufacturing sites serving the automotive business apply the IATF 16949 standard**. The IATF certifications confirm our compliance with requirements regarding the quality management system in the automotive industry. Referring to customer requirements and customer specific requirements ("CSR") TDK always has and will continue to have the policy of respecting individual agreements. Even if IATF 16949 may appear to support the acceptance of unilateral requirements, we hereby like to emphasize that **only requirements mutually agreed upon can and will be implemented in our Quality Management System**. For clarification purposes we like to point out that obligations from IATF 16949 shall only become legally binding if individually agreed upon.

Important notes

8. The trade names EPCOS, CarXield, CeraCharge, CeraDiode, CeraLink, CeraPad, CeraPlas, CSMP, CTVS, DeltaCap, DigiSiMic, FilterCap, FormFit, InsuGate, LeaXield, MediPlas, MiniBlue, MiniCell, MKD, MKK, ModCap, MotorCap, PCC, PhaseCap, PhaseCube, PhaseMod, PhiCap, PiezoBrush, PlasmaBrush, PowerHap, PQSine, PQvar, SIFERRIT, SIFI, SIKOREL, SilverCap, SIMDAD, SiMic, SIMID, SineFormer, SIOV, ThermoFuse, WindCap, XieldCap are **trademarks registered or pending** in Europe and in other countries. Further information will be found on the Internet at www.tdk-electronics.tdk.com/trademarks.

Release 2023-08